

ALUMINIUM PROFILES FOR TRUCK SIDES, VANS AND TRUCK FLOORS

ALUMINIUM PROFILES FOR TRUCKS SIDES

Interlocking profiles for truck sides of 25 mm

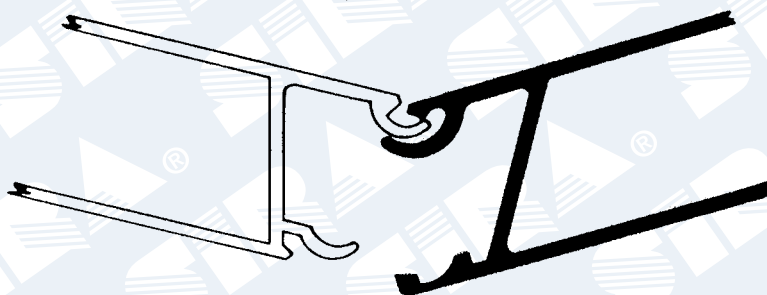

SERIES TS

Higher profiles

V 1044

Kg/ml 2,254
 Lenght 7,5 m
 Lenght 6,6 m
 Lenght 6,2 m

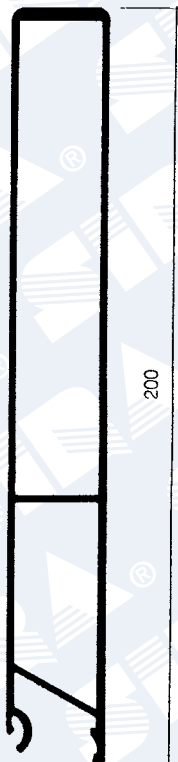

V 1050

Kg/ml 1,701
 Lenght 7,5 m

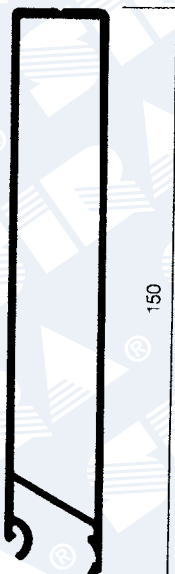

V 1055

Kg/ml 1,242
 Lenght 7,5 m



ALUMINIUM PROFILES FOR TRUCK SIDES, VANS AND TRUCK FLOORS

ALUMINIUM PROFILES FOR TRUCKS SIDES

Intermediate profiles

V 1043

Kg/ml	2,319
Lenght	7,5 m
Lenght	6,6 m
Lenght	6,2 m

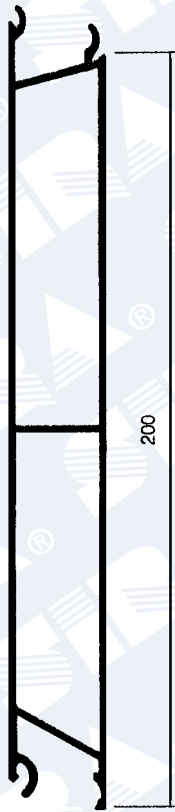

V 1051

Kg/ml	1,761
Lenght	7,5 m



V 1048

Kg/ml	1,302
Lenght	7,5 m
Lenght	6,6 m
Lenght	6,2 m



ALUMINIUM PROFILES FOR TRUCK SIDES, VANS AND TRUCK FLOORS

ALUMINIUM PROFILES FOR TRUCK SIDES

TIR intermediate profiles



V 1047

Kg/ml	2,190
Lenght	7,5 m
Lenght	6,6 m
Lenght	6,2 m



V 1032

Kg/ml	2,389
Lenght	7,5 m
Lenght	6,6 m
Lenght	6,2 m

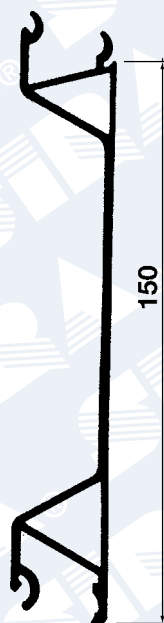

V 1052

Kg/ml	1,667
Lenght	7,5 m

TS profile for TIR with hollow

V 1057

Kg/ml	2,497
Lenght	7,5 m
Lenght	6,6 m

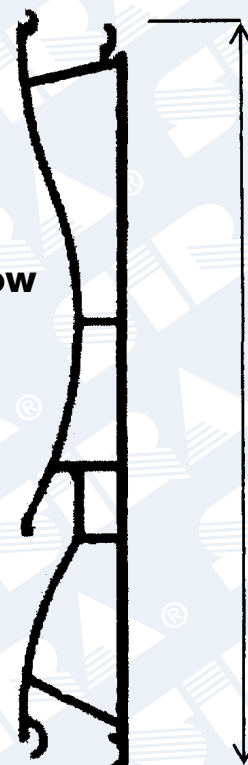

ALUMINIUM PROFILES FOR TRUCK SIDES, VANS AND TRUCK FLOORS

ALUMINIUM PROFILES FOR TRUCK SIDES

Lower profiles

Inverted ledge

V 1045

Kg/ml 2,555
 Length 7,5 m
 Length 6,6 m
 Length 6,2 m

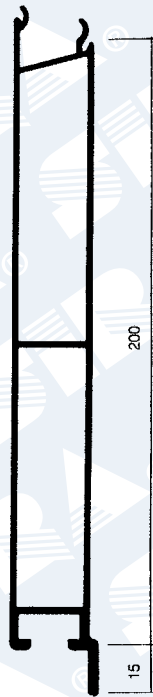

V 1049

Kg/ml 2,557
 Length 7,5 m

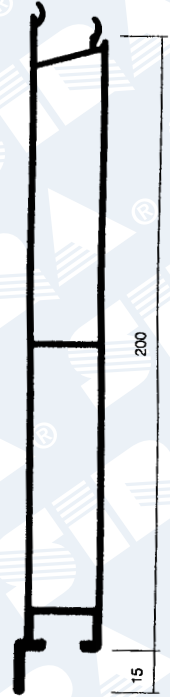

V 1046

Kg/ml 2,575
 Length 7,5 m
 Length 6,6 m
 Length 6,2 m

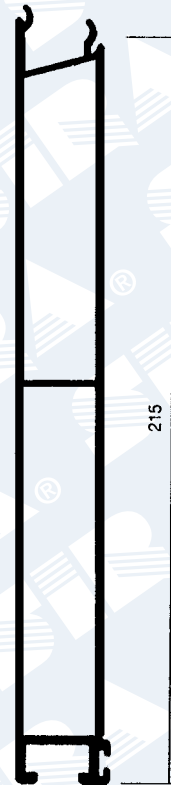

V 1054

Kg/ml 1,996
 Length 7,5 m



T 40050

Rubber gasket for profile V1046.
 Sales per meter



ALUMINIUM PROFILES FOR TRUCK SIDES, VANS AND TRUCK FLOORS

ALUMINIUM PROFILES FOR TRUCK SIDES

Higher profiles for tipper truck sides

V 1076

Kg/ml	2,663
Lenght	7,5 m
Lenght	6,6 m
Lenght	6,2 m

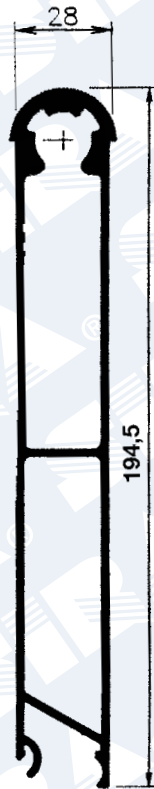

V 1528

Kg/ml	3,408
Lenght	7,5 m
Lenght	6,6 m
Lenght	6,2 m

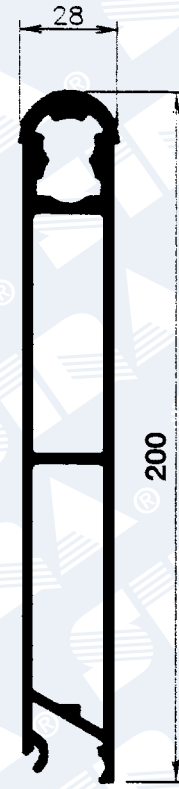

ALUMINIUM PROFILES FOR TRUCK SIDES, VANS AND TRUCK FLOORS

ALUMINIUM PROFILES FOR TRUCK SIDES

Lower profiles for tipper truck sides

V 1098

Kg/ml	4,492
Lenght	7,5 m
Lenght	6,6 m
Lenght	6,2 m

V 1075

Kg/ml	2,682
Lenght	7,5 m
Lenght	6,6 m
Lenght	6,2 m

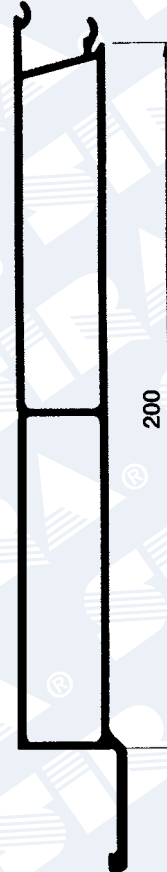
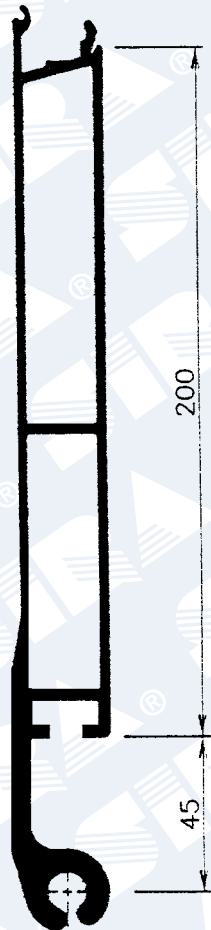

ALUMINIUM PROFILES FOR TRUCK SIDES, VANS AND TRUCK FLOORS

ALUMINIUM PROFILES FOR TRUCK SIDES

Jointed profiles for truck sides by 25 mm

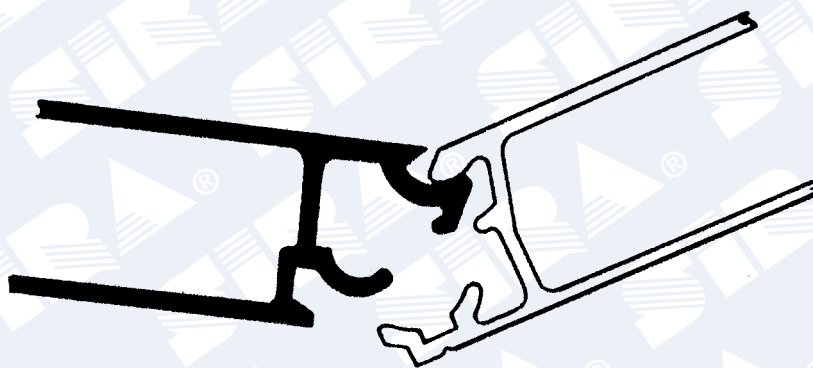

SERIES TR1

Higher profiles

V 1183

Kg/ml	2,425
Lenght	7,5 m
Lenght	6,6 m
Lenght	6,0 m

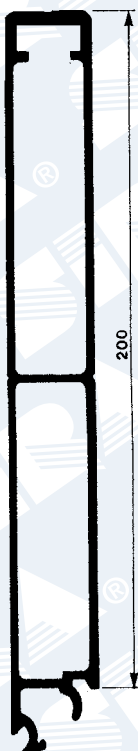

V 1308

Kg/ml	2,103
Lenght	7,5 m

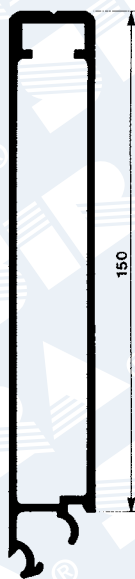

V 1309

Kg/ml	1,617
Lenght	7,5 m



ALUMINIUM PROFILES FOR TRUCK SIDES, VANS AND TRUCK FLOORS

ALUMINIUM PROFILES FOR TRUCK SIDES

Intermediate profiles

V 1186

V 1315

V 1307

Kg/ml 2,360
 Lenght 7,5 m
 Lenght 6,6 m
 Lenght 6,0 m

Kg/ml 2,063
 Lenght 7,5 m

Kg/ml 1,582
 Lenght 7,5 m

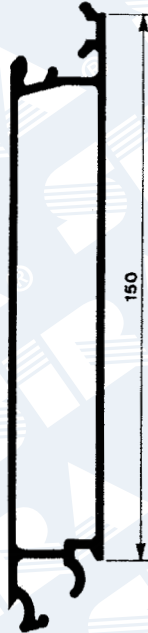
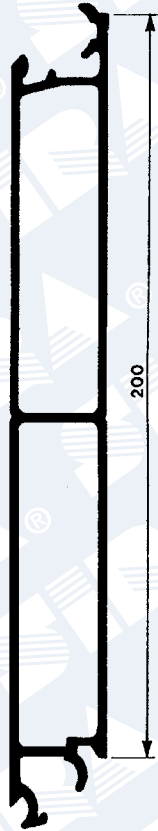

ALUMINIUM PROFILES FOR TRUCK SIDES, VANS AND TRUCK FLOORS

ALUMINIUM PROFILES FOR TRUCK SIDES

TIR intermediate profiles

V 1350

Kg/ml	2,417
Lenght	7,5 m
Lenght	6,6 m
Lenght	6,0 m

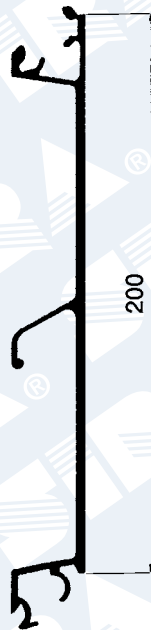

V 1184

Kg/ml	1,898
Lenght	7,5 m
Lenght	6,6 m
Lenght	6,2 m

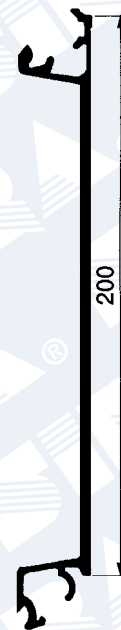

V 1188

Kg/ml	2,640
Lenght	7,5 m
Lenght	6,6 m

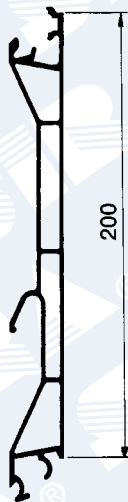

V 1306

Kg/ml	1,822
Lenght	7,5 m



ALUMINIUM PROFILES FOR TRUCK SIDES, VANS AND TRUCK FLOORS

ALUMINIUM PROFILES FOR TRUCK SIDES

Lower profiles

V 1185

Kg/ml 2,500
 Lenght 7,5 m
 Lenght 6,6 m
 Lenght 6,0 m

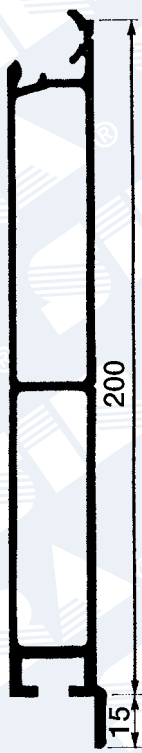

V 1310

Kg/ml 2,160
 Lenght 7,5 m

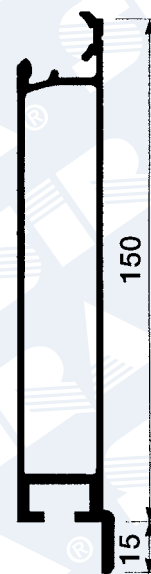

V 1187

Kg/ml 1,534
 Lenght 7,5 m

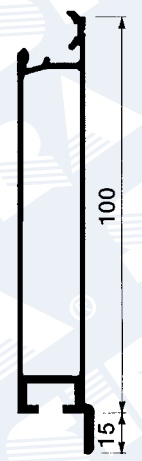

V 1314

Kg/ml 2,822
 Lenght 7,5 m
 Lenght 6,6 m

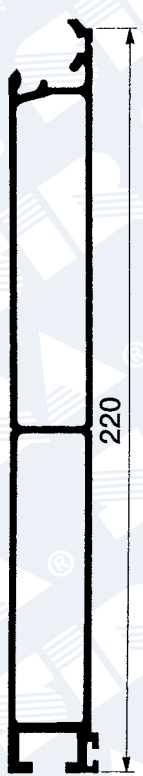

V 1189

Kg/ml 2,832
 Lenght 7,5 m
 Lenght 6,6 m

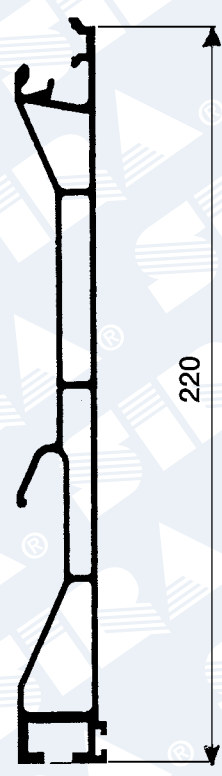

V 1311

Kg/ml 2,751
 Lenght 7,5 m

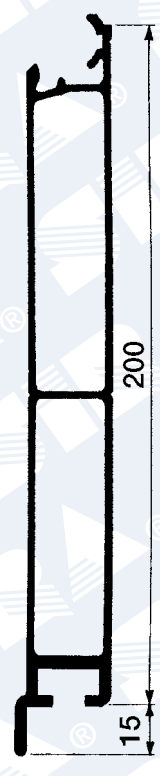

Inverted ledge

ALUMINIUM PROFILES FOR TRUCK SIDES, VANS AND TRUCK FLOORS

ALUMINIUM PROFILES FOR TRUCK SIDES

Profiles for tipper truck sides

V 1408

Kg/ml 2,879
 Length 7,5 m
 Length 6,6 m

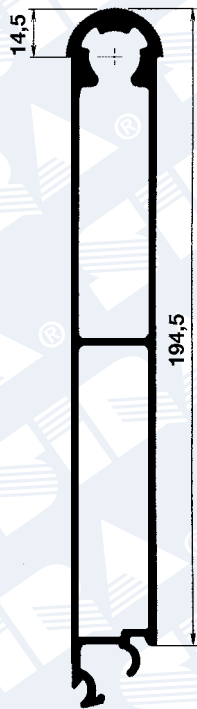

V 1410

Kg/ml 2,656
 Length 7,5 m
 Length 6,6 m

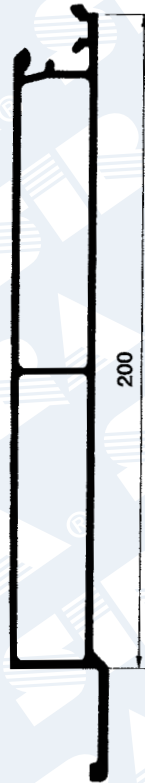

V 1527

Kg/ml 4,617
 Length 7,5 m
 Length 6,6 m

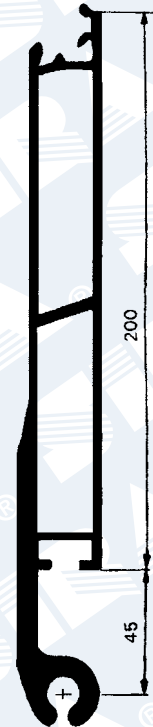

ALUMINIUM PROFILES FOR TRUCK SIDES, VANS AND TRUCK FLOORS

ALUMINIUM PROFILES FOR TRUCK SIDES

Interlocking profiles for truck sides of 25 mm

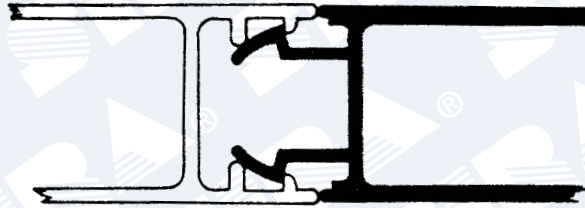

ALUCAR SERIES

Higher profiles

V 1101

Kg/ml 2,260
Lenght 7,5 m

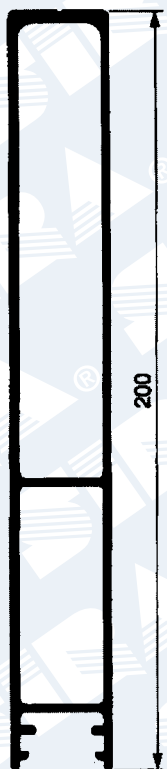

V 1102

Kg/ml 1,699
Lenght 7,5 m

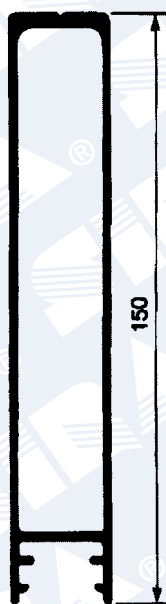

V 1165

Kg/ml 1,240
Lenght 7,5 m



ALUMINIUM PROFILES FOR TRUCK SIDES, VANS AND TRUCK FLOORS

ALUMINIUM PROFILES FOR TRUCK SIDES

Intermediate profiles

V 1103

Kg/ml 2,292
Lenght 7,5 m

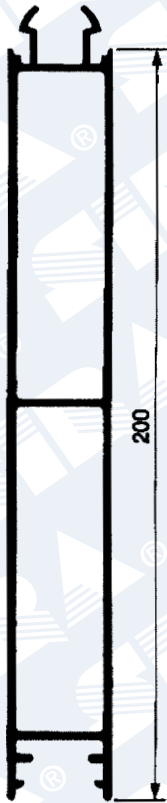

V 1104

Kg/ml 1,731
Lenght 7,5 m

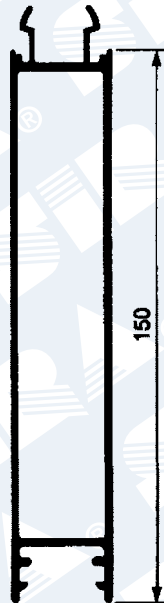

V 1105

Kg/ml 1,272
Lenght 7,5 m



ALUMINIUM PROFILES FOR TRUCK SIDES, VANS AND TRUCK FLOORS

ALUMINIUM PROFILES FOR TRUCK SIDES

TIR intermediate profiles

V 1120

Kg/ml 2,174
Lenght 7,5 m

V 1121

Kg/ml 1,796
Lenght 7,5 m



ALUMINIUM PROFILES FOR TRUCK SIDES, VANS AND TRUCK FLOORS

ALUMINIUM PROFILES FOR TRUCK SIDES

Lower profiles

V 1107

Kg/ml 2,022
Length 7,5 m

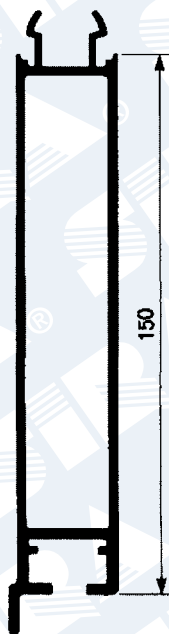

V 1106

Kg/ml 2,583
Length 7,5 m

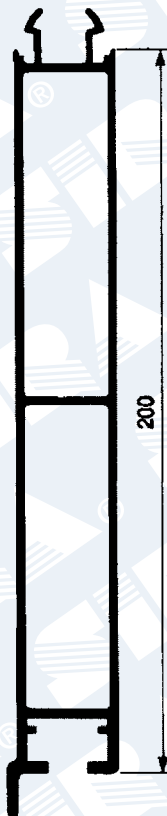

V 1109

Kg/ml 2,511
Length 7,5 m

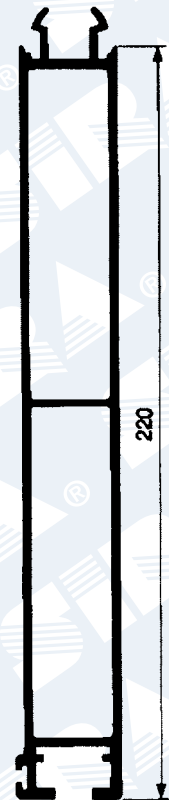

ALUMINIUM PROFILES FOR TRUCK SIDES, VANS AND TRUCK FLOORS

ALUMINIUM PROFILES FOR TRUCK SIDES

Supplementary profiles

V 1305

Kg/ml 0,756
Length 6,0 m

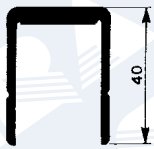

V 1312

Kg/ml 0,918
Length 6,0 m

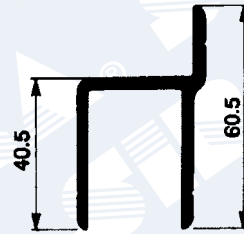

V 1313

Kg/ml 1,009
Length 6,0 m

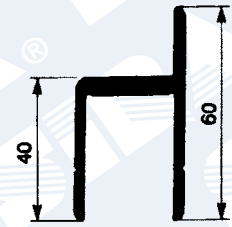

V 1336

Kg/ml 2,109
Length 6,0 m



V 1396

Kg/ml 0,823
Length 6,0 m

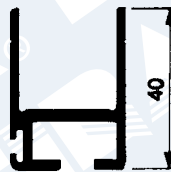

T 40050

Gasket rubber
for profile V 1396
Sales by mt



ALUMINIUM PROFILES FOR TRUCK SIDES, VANS AND TRUCK FLOORS

ALUMINIUM PROFILES FOR TRUCK SIDES

Jointed profiles for truck sides by 40 mm - SERIES TR5

V 1392

Kg/ml	4,700
Length	7,5 m
Length	6,6 m
Length	6,0 m

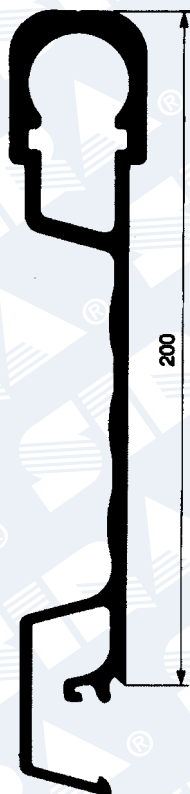

V 1393

Kg/ml	3,966
Length	7,5 m
Length	6,6 m



Higher profiles

V 1394

Kg/ml	2,794
Length	7,5 m
Length	6,6 m

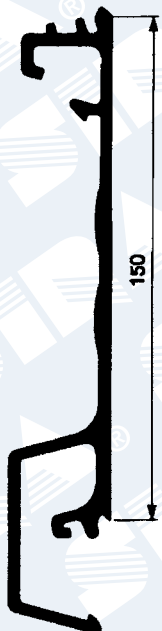

V 1391

Kg/ml	3,340
Length	7,5 m
Length	6,6 m
Length	6,0 m

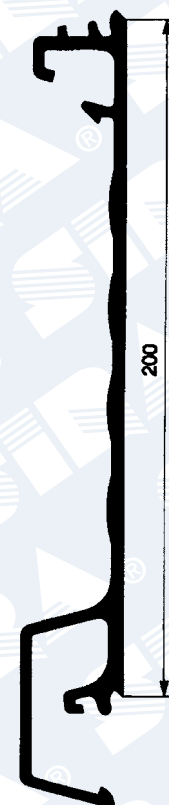

Intermediate profiles

ALUMINIUM PROFILES FOR TRUCK SIDES, VANS AND TRUCK FLOORS

ALUMINIUM PROFILES FOR TRUCK SIDES

Lower profiles

V 1356

Kg/ml 3,985
 Length 7,5 m
 Length 6,6 m
 Length 6,0 m

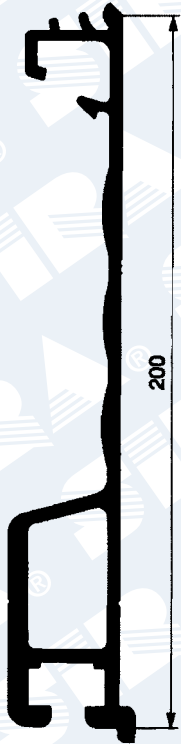

V 1385

Kg/ml 3,970
 Length 7,5 m
 Length 6,6 m
 Length 6,0 m

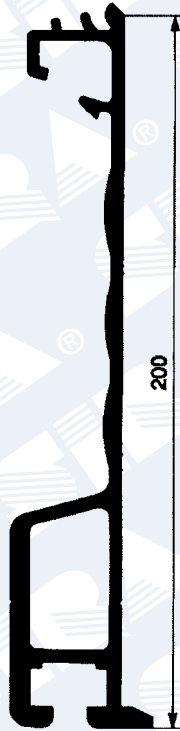

V 1559

Kg/ml 5,313
 Length 7,5 m
 Length 6,6 m
 Length 6,0 m



V 1357

Kg/ml 1,817
 Length 6,0 m

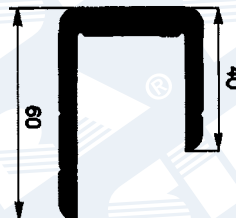

ALUMINIUM PROFILES FOR TRUCK SIDES, VANS AND TRUCK FLOORS

ALUMINIUM PROFILES FOR TRUCK SIDES

Jointed profiles for truck sides by 30 mm. - SERIES 5R

V 1190

Kg/ml 4,60
 Length 7,5 m
 Length 6,6 m
 Length 6,0 m



V 1191

Kg/ml 3,20
 Length 7,5 m
 Length 6,6 m
 Length 6,0 m



V 1192

Kg/ml 1,73
 Length 7,5 m
 Length 6,6 m
 Length 6,0 m

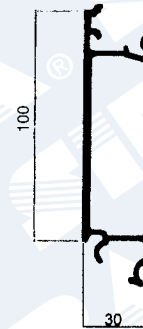

V 1193

Kg/ml 5,13
 Length 7,5 m
 Length 6,6 m
 Length 6,0 m



V 1194

Kg/ml 3,80
 Length 7,5 m
 Length 6,6 m
 Length 6,0 m

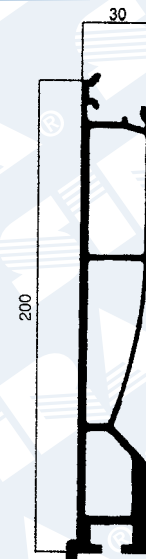

ALUMINIUM PROFILES FOR TRUCK SIDES, VANS AND TRUCK FLOORS

ALUMINIUM PROFILES FOR TRUCK SIDES

Jointed profiles for truck sides by 25 mm

V 10290

Kg/ml 2,770
Length 3175 mm

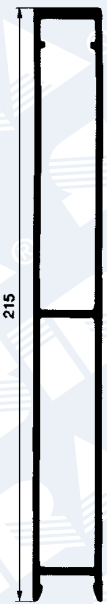

V 10291

Kg/ml 2,600
Length 3175 mm

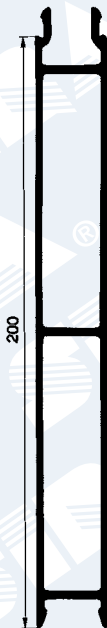

V 10292

Kg/ml 2,050
Length 3175 mm

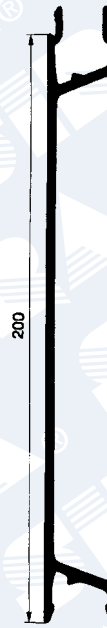

V 10293

Kg/ml 2,775
Length 3175 mm



V 10296

Kg/ml 2,450
Length 3175 mm



V 10297

Kg/ml 2,300
Length 3175 mm

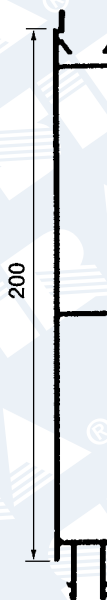

V 10298

Kg/ml 2,090
Length 3175 mm



V 10299

Kg/ml 2,750
Length 3175 mm

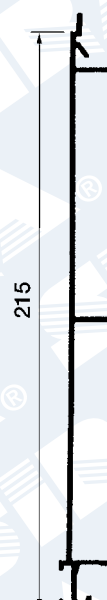

ALUMINIUM PROFILES FOR TRUCK SIDES, VANS AND TRUCK FLOORS

ALUMINIUM PROFILES FOR TRUCK SIDES

Jointed profiles for truck sides by 25 mm

V 10270

Kg/ml 2,400
Length 3250 mm

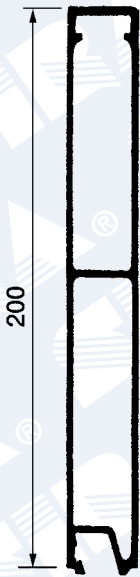

V 10271

Kg/ml 2,500
Length 3250 mm

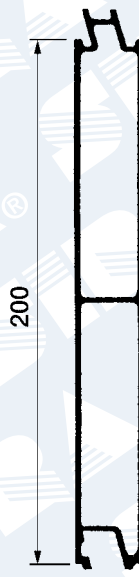

V 10272

Kg/ml 2,200
Length 3250 mm



V 10280

Kg/ml 3,200
Length 3250 mm

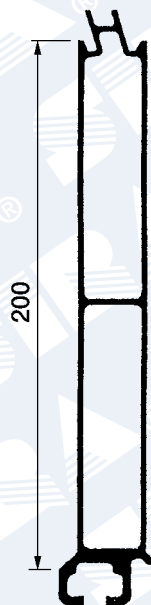

V 10273

Kg/ml 2,700
Length 3250 mm

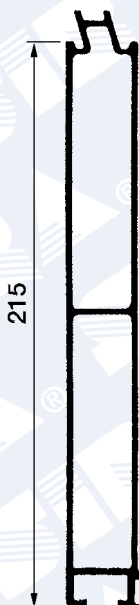

V 10274

Kg/ml 2,600
Length 3250 mm



ALUMINIUM PROFILES FOR TRUCK SIDES, VANS AND TRUCK FLOORS

ALUMINIUM PROFILES FOR CARLINES

V 1143

Kg/ml 1,032
 Length 7,5 m
 Length 6,6 m
 Length 6,0 m
 Length 4,5 m

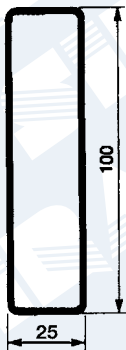

V 1341

Kg/ml 1,366
 Length 7,5 m



V 9184

Kg/ml 1,050
 Length 7,5 m
 Length 6,6 m
 Length 6,0 m
 Length 4,6 m



V 9185

Kg/ml 1,903
 Length 7,5 m
 Length 6,6 m
 Length 6,0 m

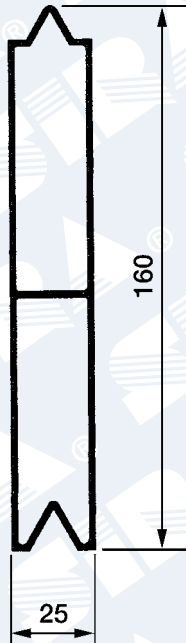

V 1359

Kg/ml 1,617
 Length 7,5 m
 Length 6,6 m
 Length 6,0 m



ALUMINIUM PROFILES FOR TRUCK SIDES, VANS AND TRUCK FLOORS

Single profiles for truck sides

V 9181

Kg/ml 2,735
Length 7,5 m

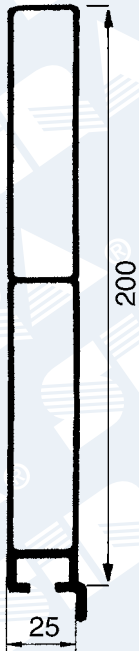

V 1997

Kg/ml 6,791
Length 7,5 m
Length 6,6 m
Length 6,0 m

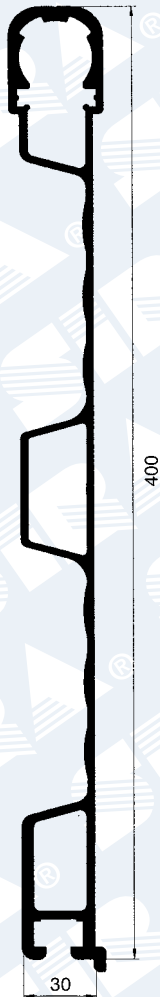

V 5059

Kg/ml 4,596
Length 7,5 m
Length 6,6 m
Length 6,0 m
Length 4,6 m



ALUMINIUM PROFILES FOR TRUCK SIDES, VANS AND TRUCK FLOORS

Single profiles for truck sides by 25 mm

V 1402

Kg/ml	4,234
Length	6,0 m
Length	6,6 m
Length	7,5 m

V 5058

Kg/ml	4,137
Length	4,5 m
Length	6,0 m
Length	6,6 m
Length	7,5 m

V 1529

Kg/ml	4,042
Length	4,5 m
Length	6,0 m
Length	6,6 m
Length	7,5 m

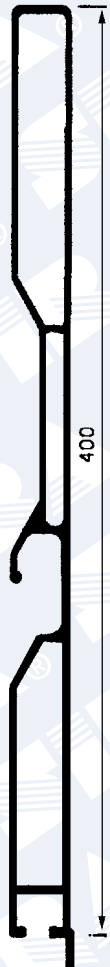
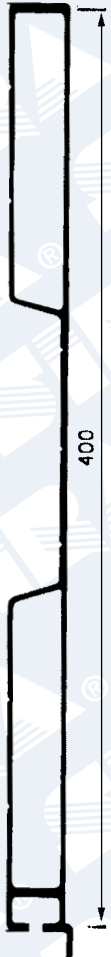

ALUMINIUM PROFILES FOR TRUCK SIDES, VANS AND TRUCK FLOORS

ALUMINIUM PROFILES FOR VANS

Fitting out profiles for vans

Higher profiles

V 2291

Kg/ml 1,274
Length 7,5 m

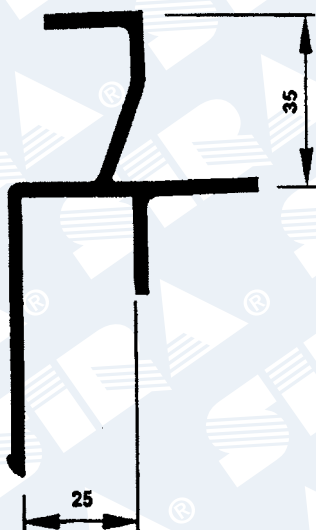

Roof bar

V 2287

Kg/ml 0,872
Length 7,5 m

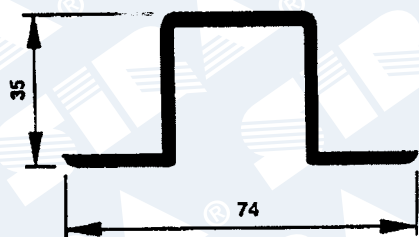

V 2302

Kg/ml 1,958
Length 7,5 m

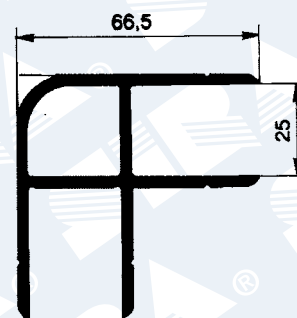

Lower profiles

V 2298

Kg/ml 1,577
Length 7,5 m

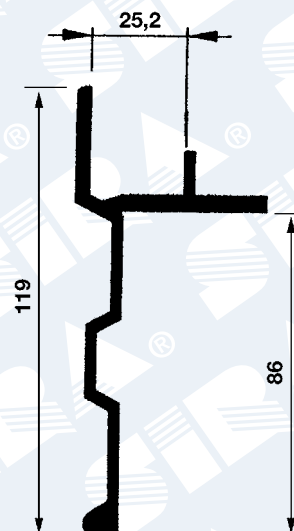

ALUMINIUM PROFILES FOR TRUCK SIDES, VANS AND TRUCK FLOORS

ALUMINIUM PROFILES FOR VANS

Fitting out profiles for vans and isothermal

Corner profiles

V 2295

Kg/ml 0,988
Length 7,5 m

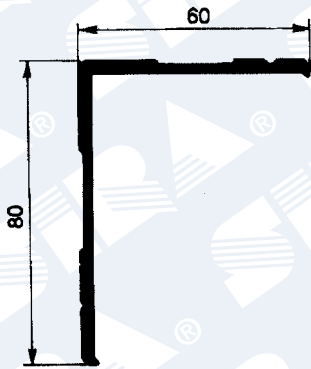

V 9186

Kg/ml 0,660
Length 7,5 m

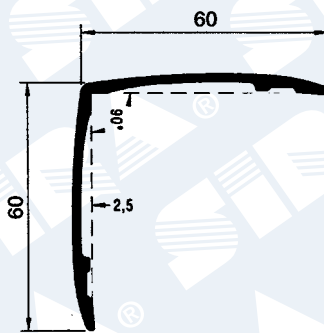

V 2362

Kg/ml 0,645
Length 7,5 m

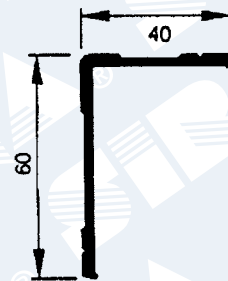

Drip profiles

VMM 2550

Gr/ml 238
Length 6,0 m

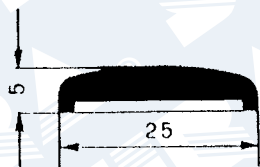

VUNG 2550

Gr/ml 140
Length 6,0 m

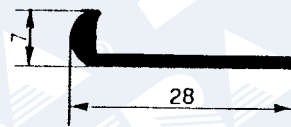

VGOC 2320

Gr/ml 265
Length 6,0 m

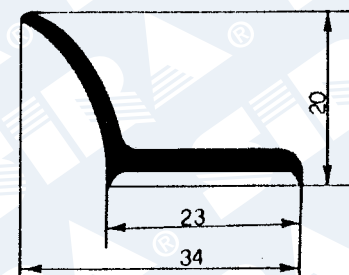

ALUMINIUM PROFILES FOR TRUCK SIDES, VANS AND TRUCK FLOORS

ALUMINIUM PROFILES FOR VANS

Fitting out profiles for vans

Profiles for door ledge

V 2288

Kg/ml 1,409
Length 7,5 m

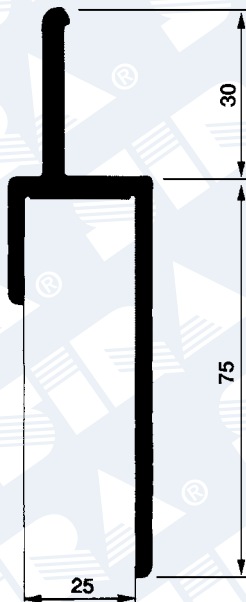

V 2289

Kg/ml 1,107
Length 7,5 m

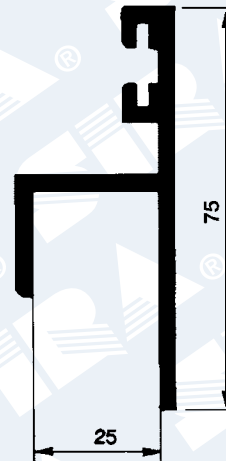

V 10310

Gasket rubber
for article V 2289
Sales by mt



Profile for panel wall

V 2297

Kg/ml 1,458
Length 7,5 m



ALUMINIUM PROFILES FOR TRUCK SIDES, VANS AND TRUCK FLOORS

ALUMINIUM PROFILES FOR VANS

Fitting out profiles for vans

V 9176

Kg/ml 1,316
 Length 7,5 m

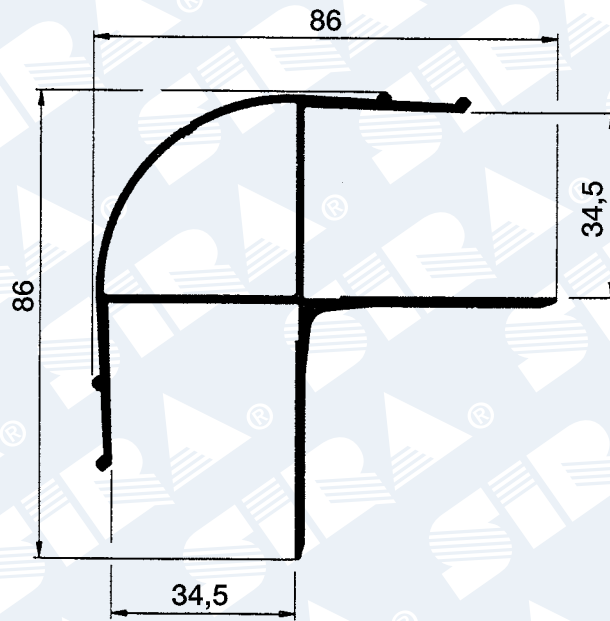

G 20465

Casting Corner
 for article V 9176

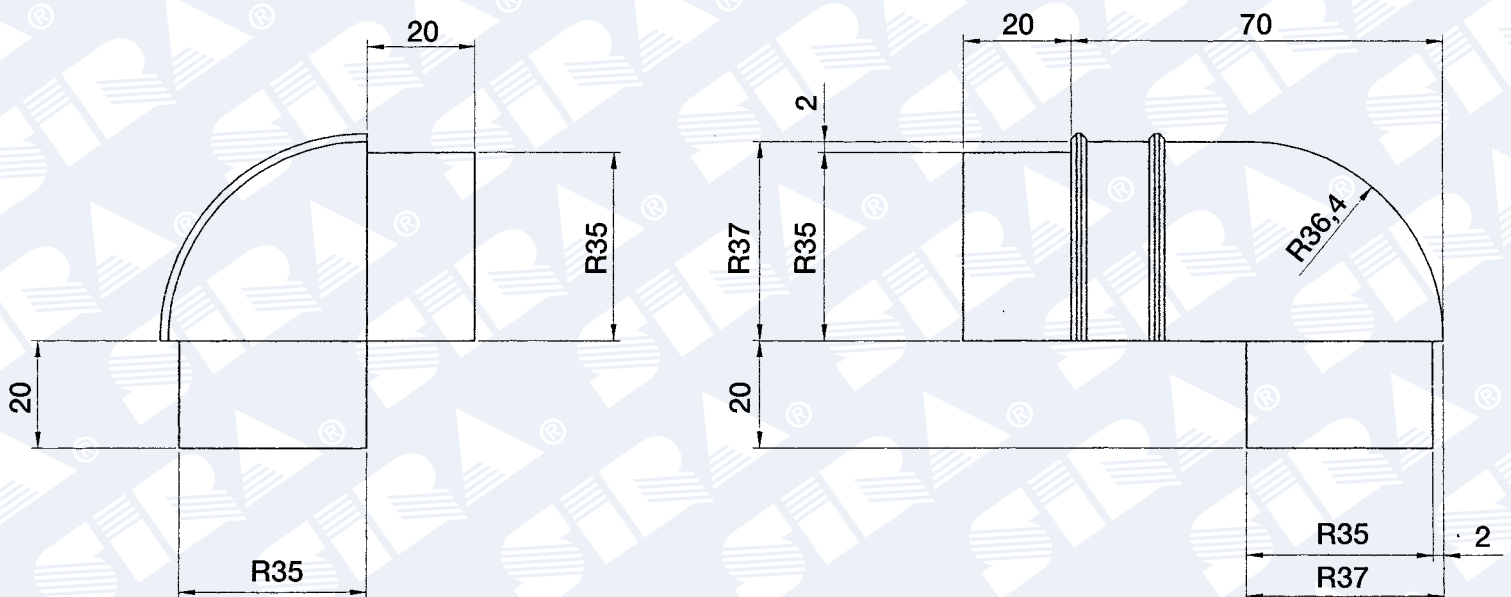

ALUMINIUM PROFILES FOR TRUCK SIDES, VANS AND TRUCK FLOORS

ALUMINIUM PROFILES FOR VANS

Fitting out profiles for vans

V 9177

Kg/ml 1,314
Length 7,5 m

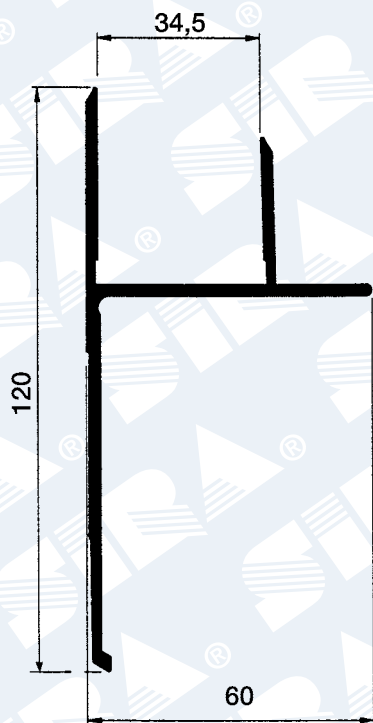

V 9179

Kg/ml 1,428
Length 7,5 m

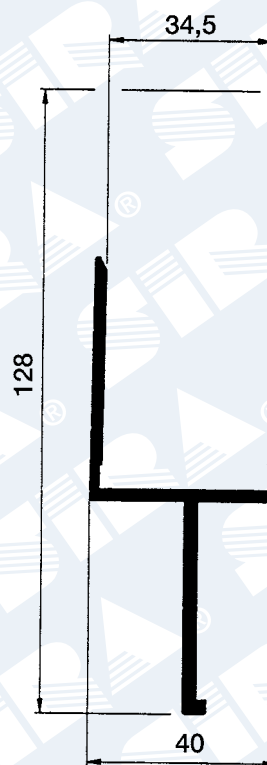

V 9178

Kg/ml 1,314
Length 7,5 m

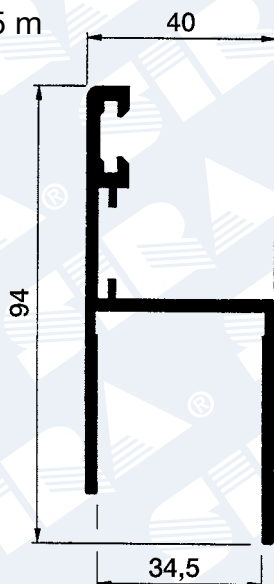

V 10310

Rubber gasket
for article V 9178
Sales by mt



ALUMINIUM PROFILES FOR TRUCK SIDES, VANS AND TRUCK FLOORS

ALUMINIUM PROFILES FOR VANS

Fitting out profiles for vans and isothermal

V 9187

Kg/ml 2,44
Length 7,5 m



V 9188

Kg/ml 2,18
Length 7,5 m



ALUMINIUM PROFILES FOR TRUCK SIDES, VANS AND TRUCK FLOORS

ALUMINIUM PROFILES FOR LOADING PLATFORM

Loading platform profiles

V 3047

Kg/ml 2,755
Length 7,5 m

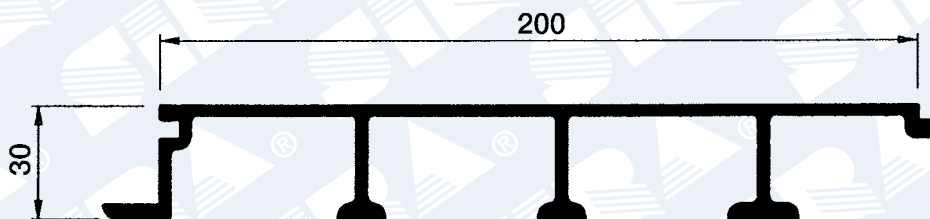

V 3080

Kg/ml 2,857
Length 7,5 m

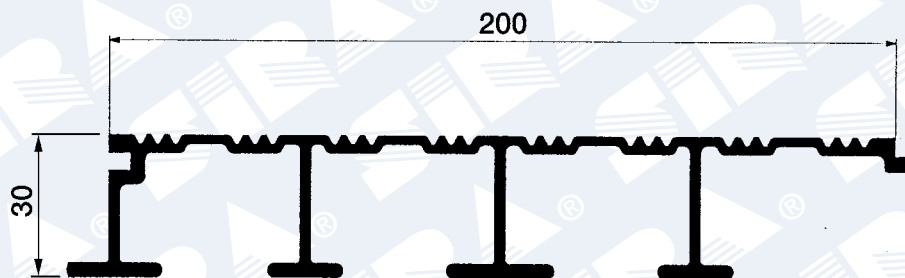

V 3008

Kg/ml 3,850
Length 7,5 m

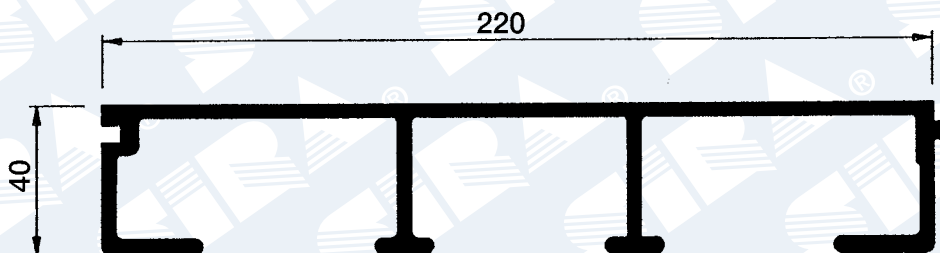

V 3009

Kg/ml 3,900
Length 7,5 m

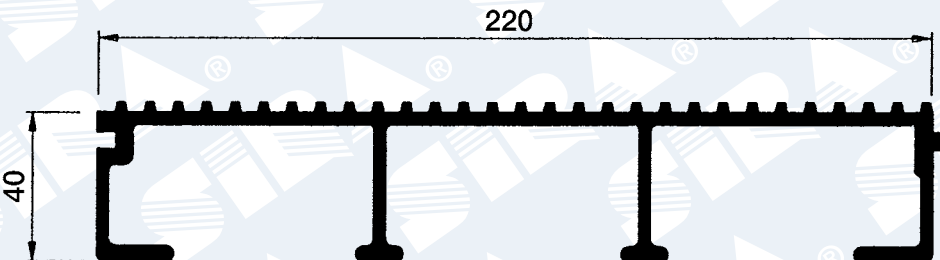

ALUMINIUM PROFILES FOR TRUCK SIDES, VANS AND TRUCK FLOORS

ALUMINIUM PROFILES FOR LATERAL PROTECTORS

Profiles for lateral protectors

V 7271

Kg/ml 1,080
Length 7,5 m



V 7270

Kg/ml 1,350
Length 6,0 m

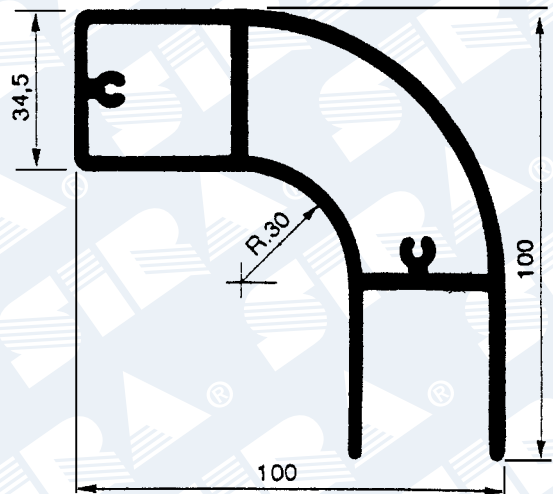

V 9182

Kg/ml 1,485
Length 7,5 m

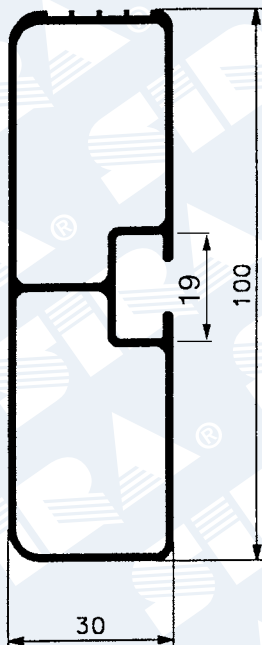

V 9183

Kg/ml 2,190
Length 6,0 m

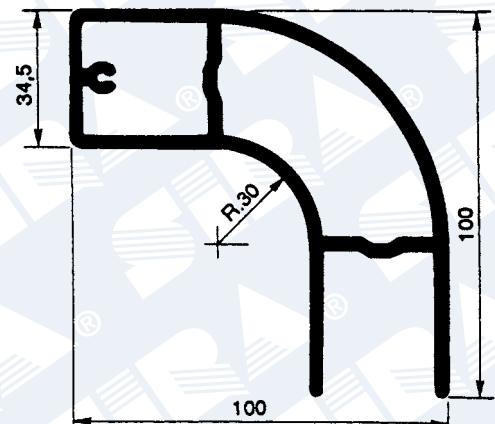

ALUMINIUM PROFILES FOR TRUCK SIDES, VANS AND TRUCK FLOORS

ALUMINIUM PROFILES FOR LATERAL PROTECTORS

Profiles for lateral protectors

V 9091

Kg/ml 2,312
Length 7,0 m

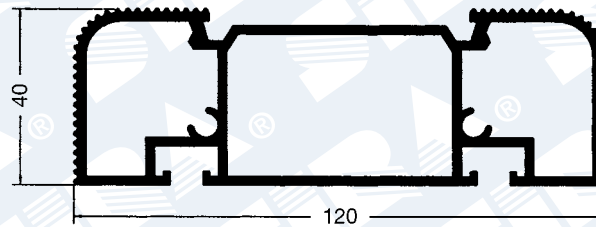

V 9090

Kg/ml 2,371
Length 5,0 m

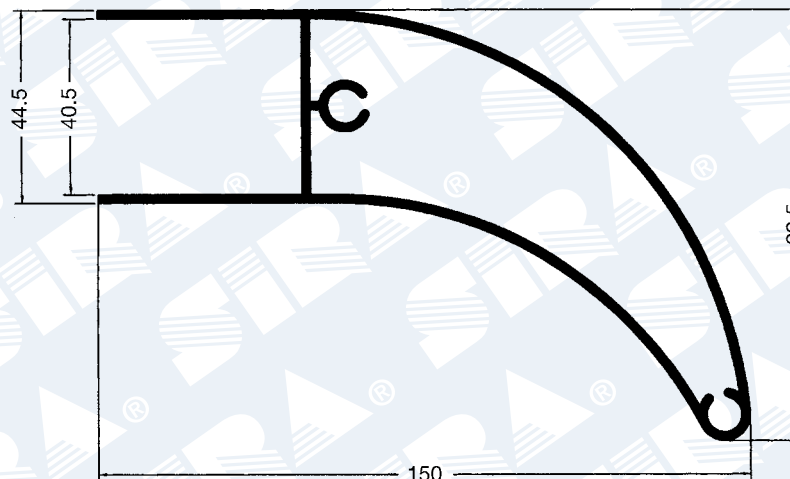

ALUMINIUM PROFILES FOR TRUCK SIDES, VANS AND TRUCK FLOORS

ALUMINIUM PROFILES FOR CARLINES FRENCH TYPE

V 9134

Kg/ml 2,120
Length 7,5 m

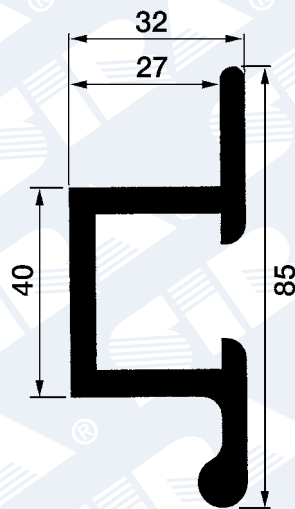

LOWER PROFILE
FOR HOOKING TARPAULIN

V 10320

Rubber gasket for profile
V 9134 sales by mt

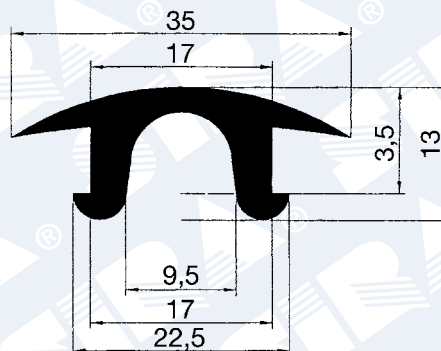

ALUMINIUM PROFILES FOR TRUCK SIDES, VANS AND TRUCK FLOORS

ALUMINIUM PROFILES FOR CARLINES FRENCH TYPE

V 9174

Kg/ml 0,962
Length 7,5 m

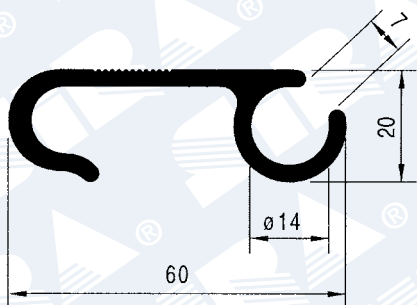

PROFILE HOOKING TARPAULIN

V 9175

Kg/ml 0,873
Length 7,5 m

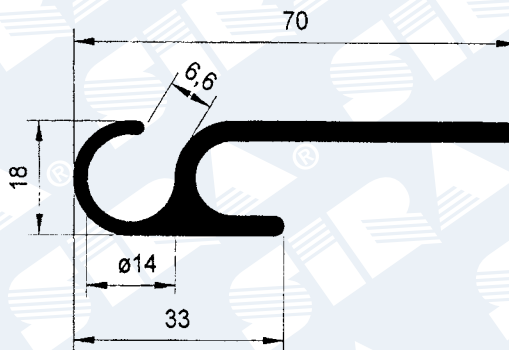

PROFILE HOOKING TARPAULIN

V 9133

Kg/ml 1,647
Length 7,5 m

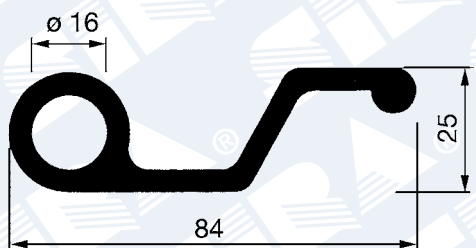

TENSIONER PROFILE

V 9135

Kg/ml 2,746
Length 7,5 m

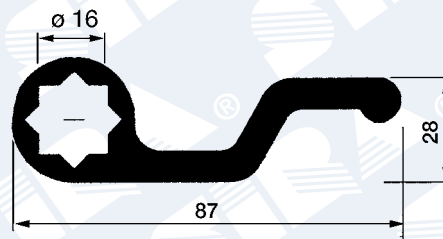

ALUMINIUM PROFILES FOR TRUCK SIDES, VANS AND TRUCK FLOORS

ALUMINIUM PLATES

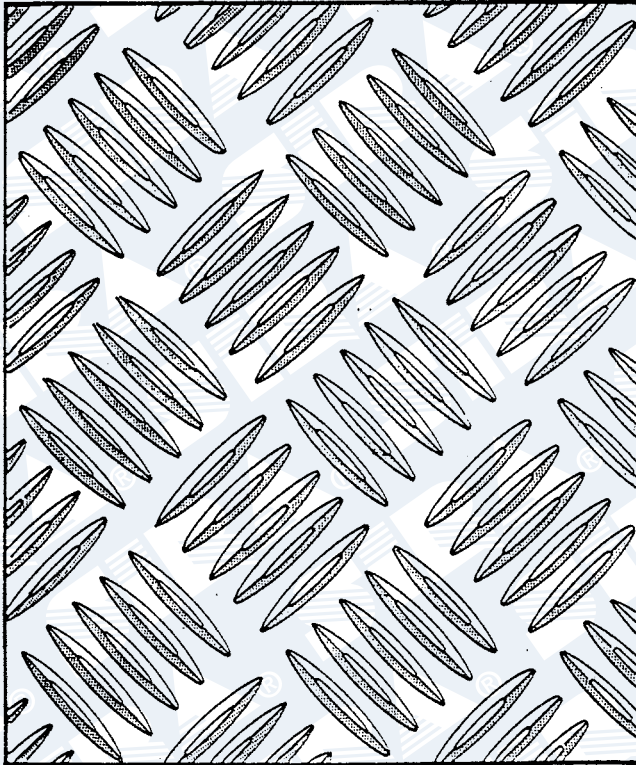

Almond plate sheet



Sheet steel in cois

Type	Code	Dimensions mm			Indicative	League
		Thickness	Height	Length	Weight	
Almond plate sheet	V 5050 102020	2*	1000	2000	12 kg	All. 99,5-1200 F
Almond plate sheet	V 5050 102025	2,5*	1000	2000	15 kg	All. 99,5-1200 F
Almond plate sheet	V 5050 102030	3*	1000	2000	18 kg	All. 99,5-1200 F
Almond plate sheet	V 5050 122520	2*	1250	2500	20 kg	All. 99,5-1200 F
Almond plate sheet	V 5050 122525	2,5*	1250	2500	25 kg	All. 99,5-1200 F
Almond plate sheet	V 5050 122530	3*	1250	2500	29 kg	All. 99,5-1200 F
Almond plate sheet	V 5050 153030	3*	1500	3000	40 kg	All. 99,5-1200 F
Almond plate sheet	V 5050 214520	2*	2100	4500	62 kg	All. 99,5-1200 F
Sheet steel in cois	V 10210	1	2550	per meter	3 kg/mq	Duralinox 3003 H16

* Without almond sheet